

On-Site Leaching Chamber Specifications & Features

Design & Installation Manual – Maine

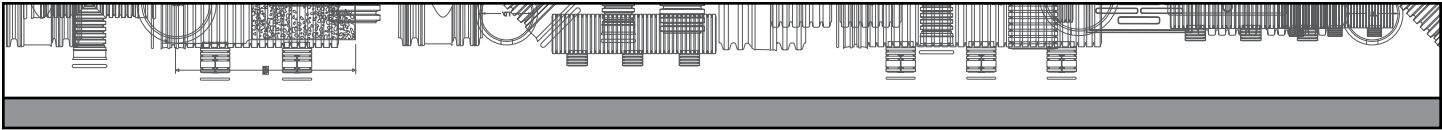



- This manual provides general design and installation information for Arc/BioDiffuser Leaching Chambers.
- All Arc/BioDiffuser chamber configurations and installations must comply with state and local rules.
- This manual contains a brief description for each chamber model and general design and installation procedures. For more detailed information please contact customer service at 1-800-733-0535.
- For CAD drawings refer to our website: www.arc-chamber.com.

Contents	
Introduction	2
<hr/>	
Product Specifications and Typical Configurations	
Arc 36 System	4
Arc 36 High Capacity System	6
11" Standard System	8
16" High Capacity System	10
Arc 18 System	12
Bio 2 System	14
<hr/>	
Installation Instructions	16
<hr/>	
Typical Installations: Trench, Bed and Serial	18-20
<hr/>	
Additional System Configurations	
Mound Configuration System	21
Pump Systems	22-23
Pressure Dosing System	24
Side Port Coupler System Options	25-26
<hr/>	
System Sizing Charts	27-30

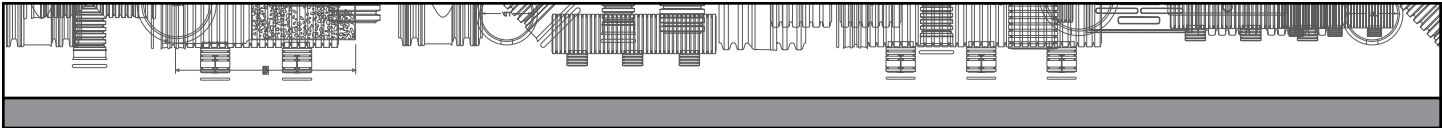

INCLUDED SYSTEMS

Arc 36 System

- 34" Wide Chamber
- New Lightweight Design with Articulating Joints
- H-10 load rated with proper installation.
- *See Pages 4-5*



Arc 36 HC System

- 34" Wide Chamber
- New Lightweight Design with Articulating Joints
- H-10 load rated with proper installation.
- *See Pages 6-7*



11" Standard System

- 34" Wide Chamber
- H-10 load rated with proper installation.
- *See Pages 8-9*

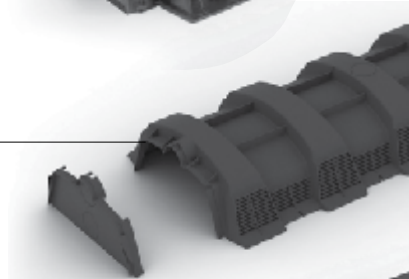

16" High Capacity System

- 34" Wide Chamber
- H-10 load rated with proper installation.
- *See Pages 10-11*

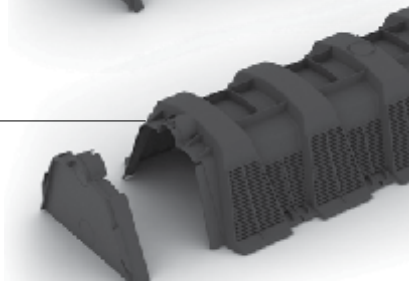

Arc 18 System

- 16" Wide Chamber
- New Lightweight Design with Articulating Joints and Pivot Lockout Feature
- H-10 load rated with proper installation.
- *See Pages 12-13*



Bio 2 System

- 15" Wide Chamber
- H-10 load rated with proper installation.
- *See Pages 14-15*

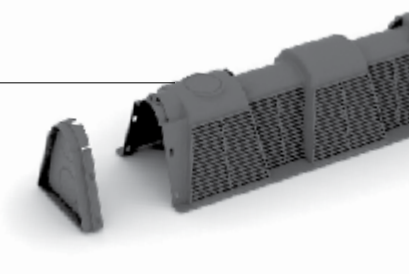

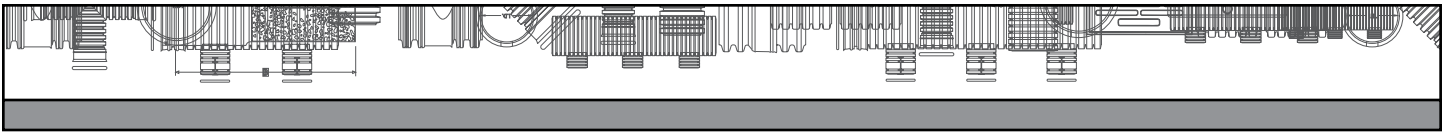

ARC 36 SYSTEM

Before beginning installation, please note the following engineered features of the Arc 36 model chambers and end caps.



Arc 36 Chamber

Length	63"
Repeat Length	60"
Overall Width	34"
Sidewall Height	7.13"
Invert Height	7.25"
Overall Height	13"
Capacity	8.04 cu ft (60.14 gal)

Calculations and dimensions are nominal

Arc 36 Chamber—Top, Side, and End Views (not to scale)

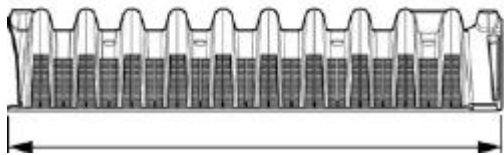
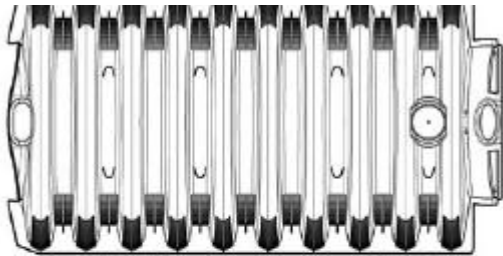

60" Effective Length

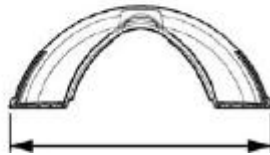

34"

Arc 36 End Cap—Side, and End Views (not to scale)

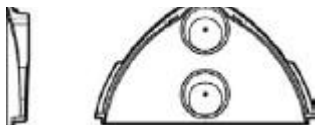

Side Port Coupler (SPC)

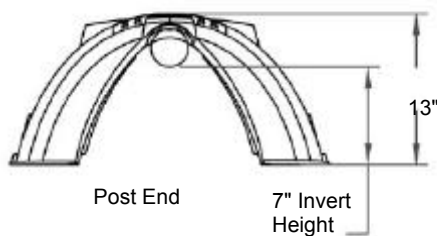

Post End

7" Invert Height

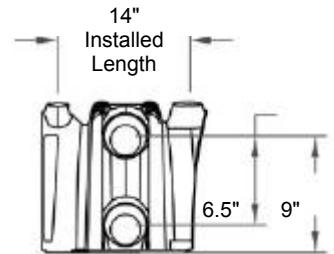

14" Installed Length

6.5"

9"

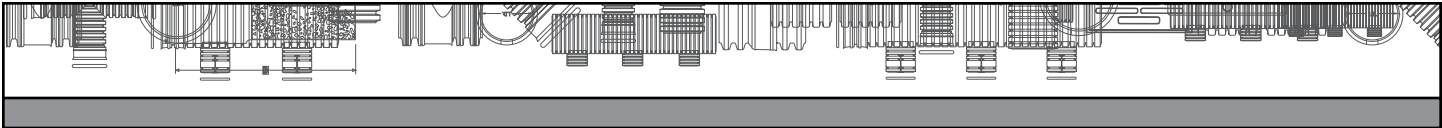

ARC 36 SYSTEM

Arc 36 Features

- The post and dome creates a positive lock securing the chambers for final engagement. Lock and drop feature for faster installation.
- The Arc 36 chamber feet are designed with an extra large surface area to provide support, particularly in sandy soils.
- Sidewall louvers are designed to allow effluent to exit the chamber sidewalls in high flow situations, while preventing soils from migrating into the chamber void.
- Observation/venting knockout ports provide for inspection of system performance as well as a convenient location for drain field ventilation pipes.
- Each chamber end has small knockouts on the roof positioned in the “Post” end joint. When removed, these knockouts allow for the use of zip ties to support piping in dosing systems.



• Lock and Drop



• Louvers and Feet



• Observation Port

Arc 36 Universal End Cap

- Upper and lower knockouts accommodate both Schedule 40 and SDR 35 piping. Knockouts can be removed with a knife or hole saw. Dimples are also offered for the positioning of hole saw pilot drills.
- End caps are designed to attach to the chamber's dome or post end in the same fashion for each end with the Arc 36 logo facing outward.



Arc 36 Swivel Feature

- The engagement mechanism of the Arc 36 chamber is designed to allow for a pivot between joined chambers of up to 10° in either direction.



Arc 36 Side Port Coupler

- Side Port Coupler component snaps in place to allow side entry at any joint throughout the trench line. This accessory provides a variety of design and installation options. Refer to pages 22 and 23 for design configurations.



Arc 36 System Configurations

- Trench Installation: Page 18
- Bed Installation: Page 19
- Additional Configurations: Pages 20-25
(Serial, Pump, Pressure Dosing, and Side Port Coupler System Options)

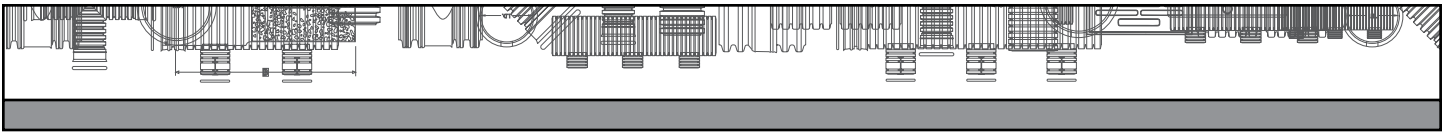

ARC 36 HC SYSTEM

Before beginning installation, please note the following engineered features of the Arc 36 HC model chambers and end caps.



Arc 36 HC Chamber

Length	63"
Repeat Length	60"
Overall Width	34"
Sidewall Height	10.75"
Invert Height	10.75"
Overall Height	16"
Capacity	10.7 cu ft (80 gal)



Calculations and dimensions are nominal

Arc 36 HC Chamber—Top, Side, and End Views (not to scale)

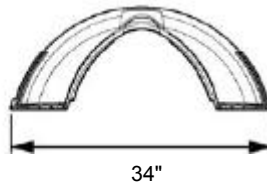
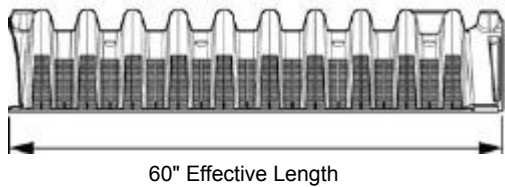
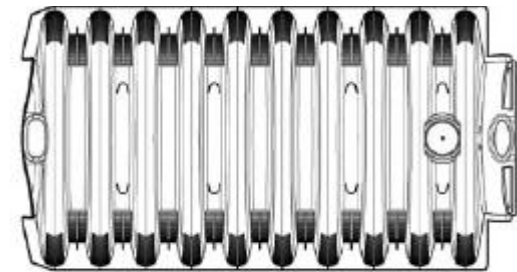

Arc 36 HC End Cap—Side, and End Views (not to scale)

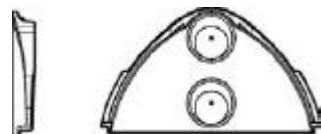

Side Port Coupler (SPC)

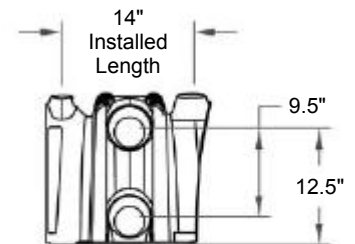
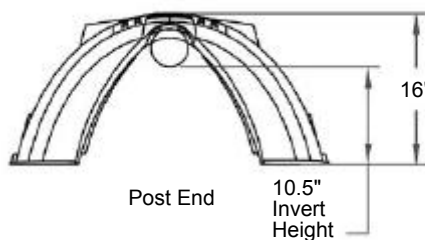

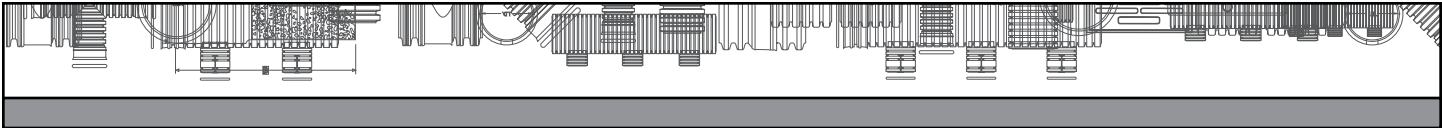

ARC 36 HC SYSTEM

Arc 36 HC Features

- The post and dome creates a positive lock securing the chambers for final engagement. Lock and drop feature for faster installation.
- The Arc 36 HC chamber feet are designed with an extra large surface area to provide support, particularly in sandy soils.
- Sidewall louvers are designed to allow effluent to exit the chamber sidewalls in high flow situations, while preventing soils from migrating into the chamber void.
- Observation/venting knockout ports provide for inspection of system performance as well as a convenient location for drain field ventilation pipes.
- Each chamber end has small knockouts on the roof positioned in the “Post” end joint. When removed, these knockouts allow for the use of zip ties to support piping in dosing systems.



• Lock and Drop



• Louvers and Feet



• Observation Port

Arc 36 HC Universal End Cap

- Upper and lower knockouts accommodate both Schedule 40 and SDR 35 piping. Knockouts can be removed with a knife or hole saw. Dimples are also offered for the positioning of hole saw pilot drills.
- End caps are designed to attach to the chamber's dome or post end in the same fashion for each end with the Arc 36 logo facing outward.

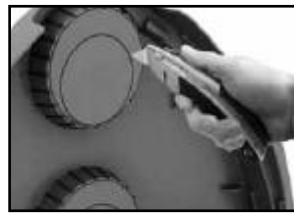

Arc 36 HC Swivel Feature

- The engagement mechanism of the Arc 36 chamber is designed to allow for a pivot between joined chambers of up to 10° in either direction.



Arc 36 HC Side Port Coupler

- Side Port Coupler component snaps in place to allow side entry at any joint throughout the trench line. This accessory provides a variety of design and installation options. Refer to pages 22 and 23 for design configurations.



Arc 36 HC System Configurations

- Trench Installation: Page 18
- Bed Installation: Page 19
- Additional Configurations: Pages 20-25
(Serial, Pump, Pressure Dosing, and Side Port Coupler System Options)

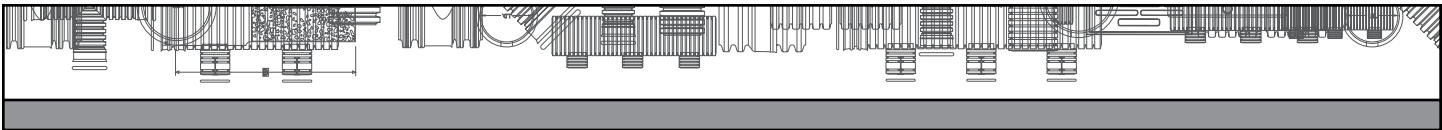

11" STANDARD SYSTEM

Before beginning installation, please note the following engineered features of the 11" Standard model chambers and end caps.

11" Standard System

- Each chamber end is either marked "Dome" or "Post" on the round observation/vent knockout ports. These indicate direction of assembly, dome over post.

11" Std Chamber

Length	76"
Repeat Length	75"
Overall Width	34"
Sidewall Height	6.35"
Invert Height	6.5"
Overall Height	11"
Capacity	9.21 cu ft (68.42 gal)

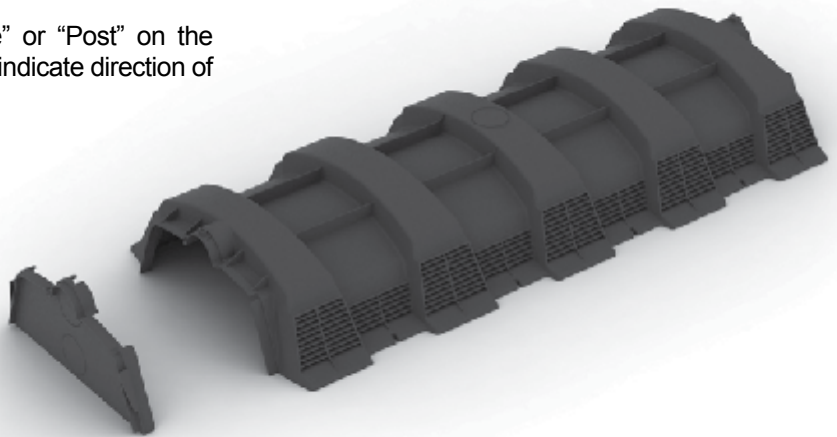

Calculations and dimensions are nominal

11" Standard Chamber — Top, Side, and End Views (not to scale)

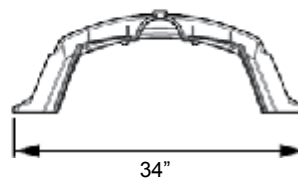
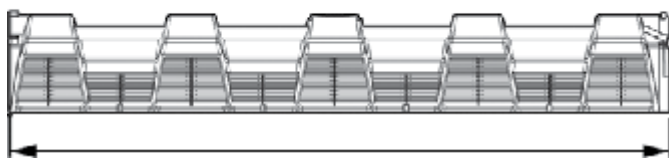
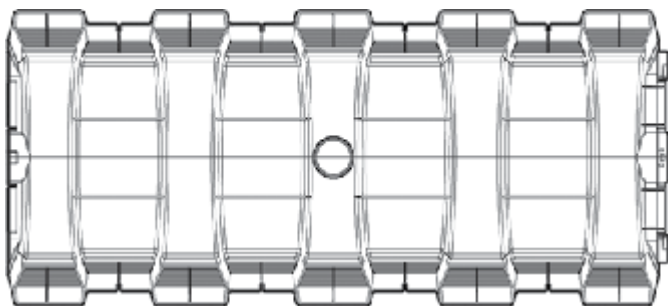

11" Standard End Cap — Side, and End Views (not to scale)

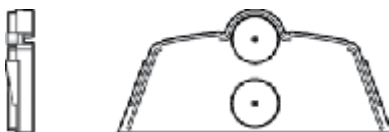

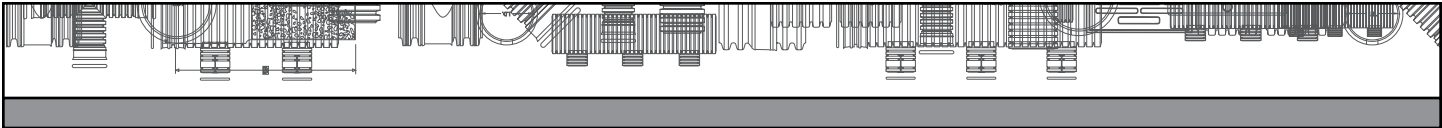

11" STANDARD SYSTEM

11" Standard Features

- The post and dome creates a positive lock securing the chambers for final engagement.
- The 11" Standard chamber feet are designed with an extra large surface area to provide support, particularly in sandy soils.
- Sidewall louvers are designed to allow effluent to exit the chamber sidewalls in high flow situations, while preventing soils from migrating into the chamber void.
- Observation/venting knockout ports provide for inspection of system performance as well as a convenient location for drain field ventilation pipes.
- Each chamber end has small knockouts on the roof positioned in the "Post" end joint. When removed, these knockouts allow for the use of zip ties to support piping in dosing systems.



• Interlocking joint



• Louvers and Feet



• Observation Port

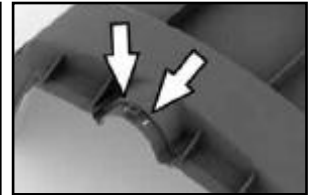

• Zip Tie Knockouts

11" Standard Universal End Cap

- Upper and lower knockouts accommodate both Schedule 40 and SDR 35 piping. Dimples are also offered for the positioning of hole saw pilot drills.
- End caps are designed to attach the chamber's dome or post end.

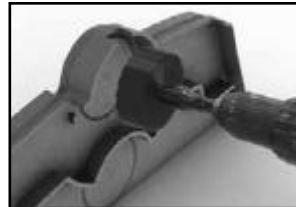

11" Standard System Configurations

- Trench Installation: Page 18
- Bed Installation: Page 19
- Additional Configurations: Pages 20-23
(Serial, Pump and Pressure Dosing Options)

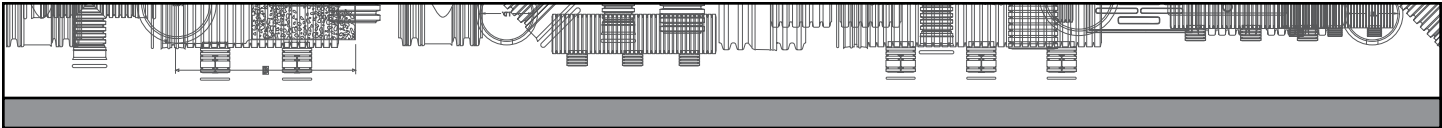

16" HIGH CAPACITY

Before beginning installation, please note the following engineered features of the 16" High Capacity model chambers and end caps.

16" High Capacity System

- Each chamber end is either marked "Dome" or "Post" on the round observation/vent knockout ports. These indicate direction of assembly, dome over post.

16" High Capacity Chamber

Length	76"
Repeat Length	75"
Overall Width	34"
Sidewall Height	11.17"
Invert Height	11.6"
Overall Height	16"
Capacity	13.6 cu ft (101.0 gal)

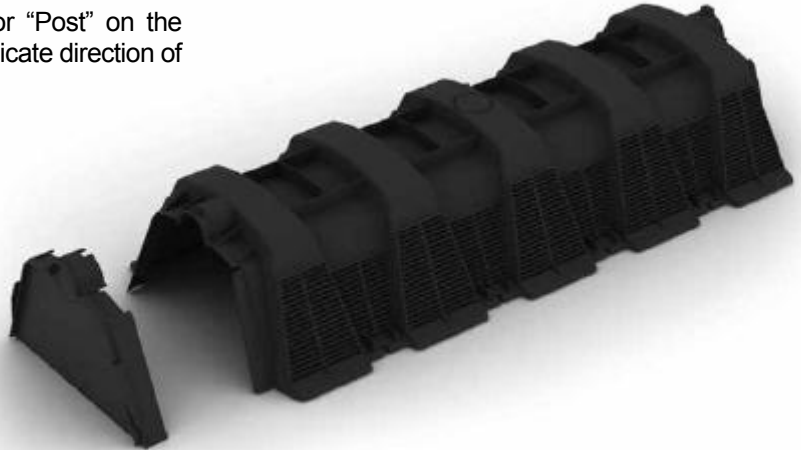

Calculations and dimensions are nominal

16" High Capacity Chamber — Top, Side, and End Views (not to scale)

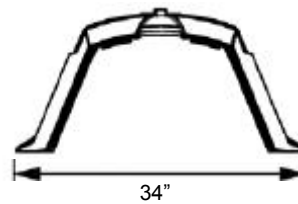
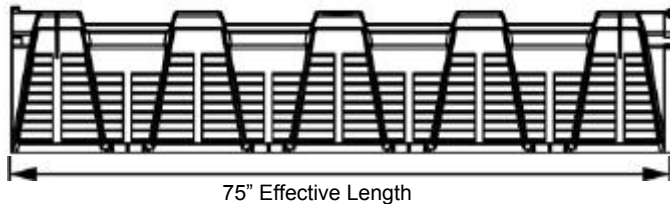
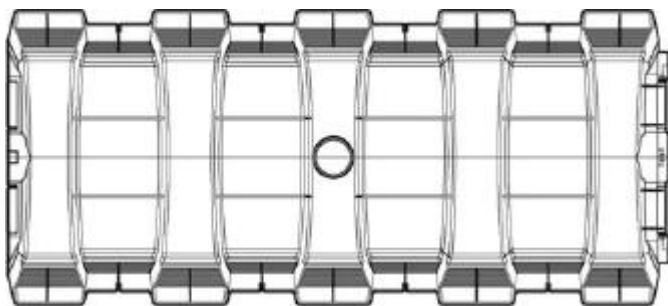

16" High Capacity End Cap — End View (not to scale)

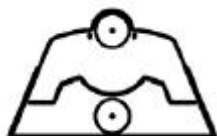

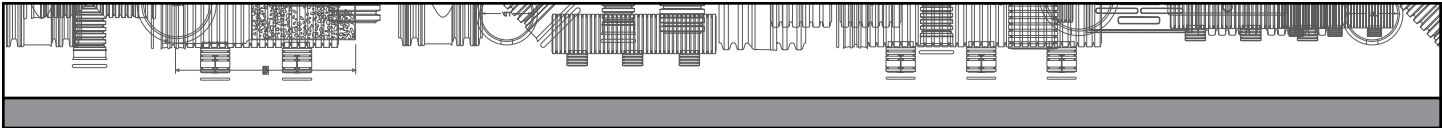

16" HIGH CAPACITY

16" High Capacity Features

- The post and dome creates a positive lock securing the chambers for final engagement.
- The 16" High Capacity chamber feet are designed with an extra large surface area to provide support, particularly in sandy soils.
- Sidewall louvers are designed to allow effluent to exit the chamber sidewalls in high flow situations, while preventing soils from migrating into the chamber void.
- Observation/venting knockout ports provide for inspection of system performance as well as a convenient location for drain field ventilation pipes.
- Each chamber end has small knockouts on the roof positioned in the "Post" end joint. When removed, these knockouts allow for the use of zip ties to support piping in dosing systems.



• Interlocking joint



• Louvers and Feet



• Observation Port

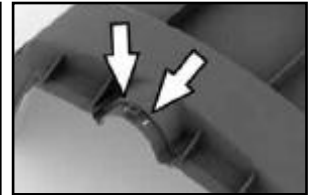

• Zip Tie Knockouts

16" High Capacity Universal End Cap

- Upper and lower knockouts accommodate both Schedule 40 and SDR 35 piping. Dimples are also offered for the positioning of hole saw pilot drills.
- End caps are designed to attach the chamber's dome or post end.

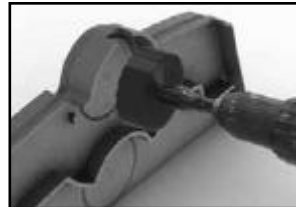

16" High Capacity System Configurations

- Trench Installation: Page 18
- Bed Installation: Page 19
- Additional Configurations: Pages 20-23
(Serial, Pump and Pressure Dosing Options)

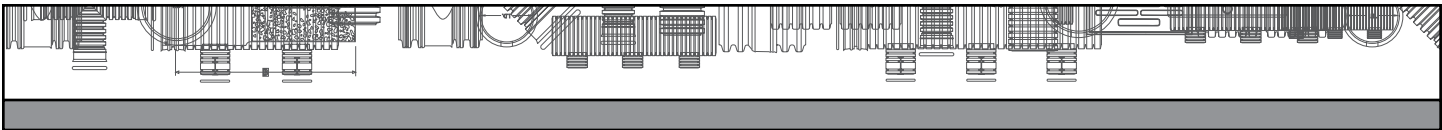

ARC 18 SYSTEM

Before beginning installation, please note the following engineered features of the Arc 18 model chambers and end caps.

Arc 18 System

- Each chamber end is either marked “Dome” or “Post” on the round observation/vent knockout ports. These indicate direction of assembly, dome over post.

Arc 18 Chamber

Length	67"
Repeat Length	60"
Overall Width	16"
Sidewall Height	7.7"
Invert Height	6.24"
Overall Height	12"
Capacity	3.42 cu ft (25.6 gal)



Calculations and dimensions are nominal

Arc 18 Chamber — Top, Side, and End Views (not to scale)

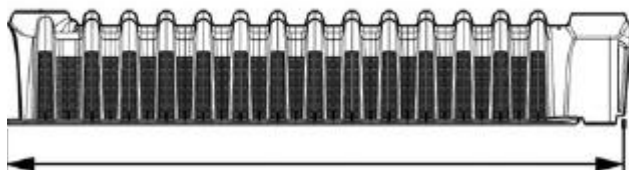
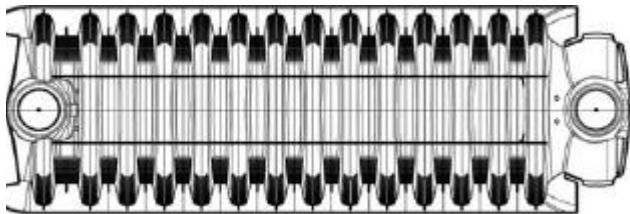

60" Effective Length



16"

Arc 18 End Cap — Side, and End Views (not to scale)



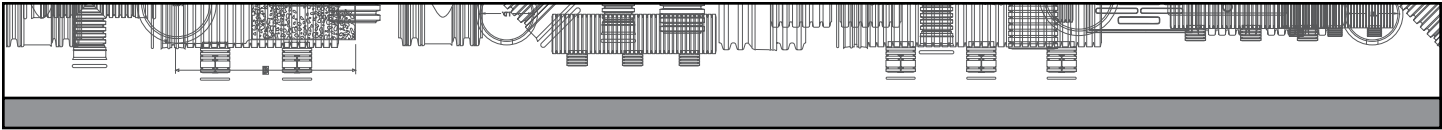

ARC 18 SYSTEM

Arc 18 Features

- Base flanges on the chambers ends over lock during final engagement to form a very strong joint.
- The Arc 18 chamber feet are designed with an extra large surface area to provide support particularly in sandy soils.
- Sidewall louvers are designed to allow effluent to exit the chamber sidewalls in high flow situations, while preventing soils from migrating into the chamber void.
- Observation/venting knockout ports provide for inspection of system performance as well as a convenient location for drain field ventilation pipes.
- Each chamber end has small knockouts on the roof positioned in the "Post" end joint. When removed, these knockouts are for the use of zip ties to support piping in dosing systems.

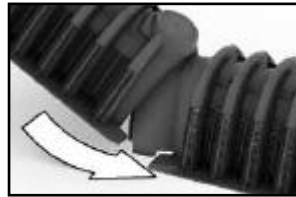

• Overlocking Ends



• Louvers and Feet



• Observation Port

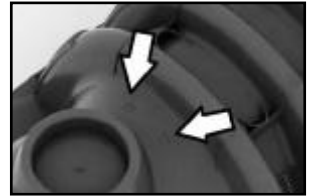

• Zip Tie Knockouts

Arc 18 End Cap

- Upper and lower knockouts accommodate both Schedule 40 and SDR 35 piping. Dimples are also offered for the positioning of hole saw pilot drills.
- End caps are designed to attach the chamber's dome or post end.



Arc 18 Swivel Feature

- Each chamber's post end has swivel lockout tabs at either base flange. When removed, the incoming chamber will turn up to ten degrees in the direction of the removed lockout tab. Without removal of the swivel lockout tab, the chambers will align in a straight pattern.
- Swivel lockout tabs may be removed carefully with a utility knife.

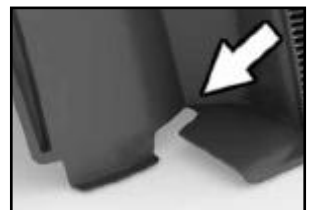
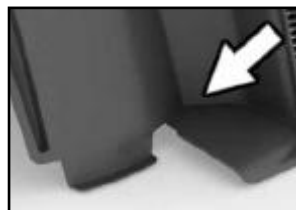

Arc 18 System Configurations

- Trench Installation: Page 18
- Bed Installation: Page 19
- Additional Configurations: Pages 20-23
(Serial, Pump and Pressure Dosing Options)

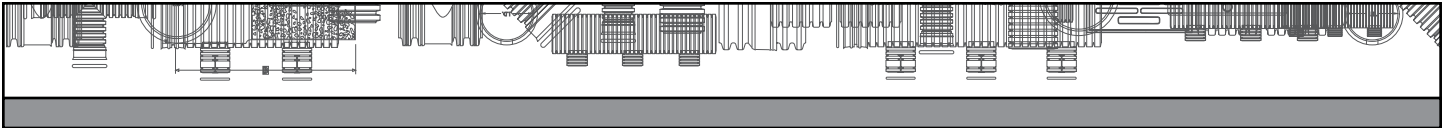

Bio 2 System

Before beginning installation, please note the following engineered features of the Bio 2 model chambers and end caps.

Bio 2 System

- Each chamber end has either a rectangular dome or “H” post. These indicate direction of assembly, dome over post.

Bio 2 Chamber	
Length	87”
Repeat Length	86”
Overall Width	15”
Sidewall Height	9.03”
Invert Height	6.95”
Overall Height	12”
Capacity	5.0 cu ft (37.1 gal)
Weight	19 lbs

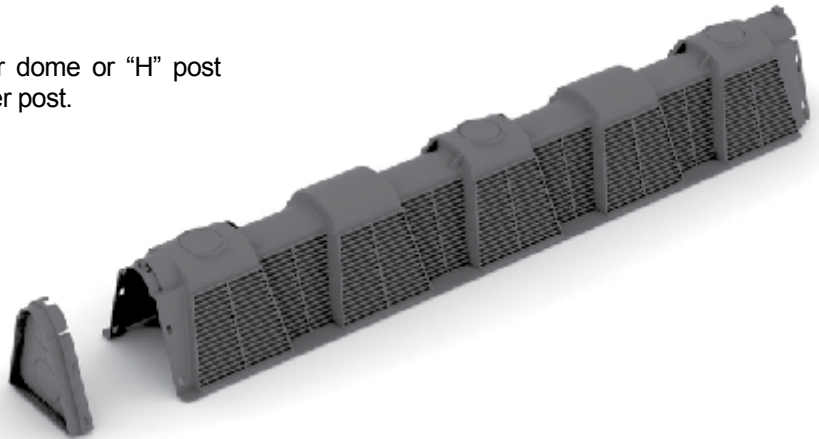

Calculations and dimensions are nominal

Bio 2 Chamber - Top, Side, and End Views (not to scale)

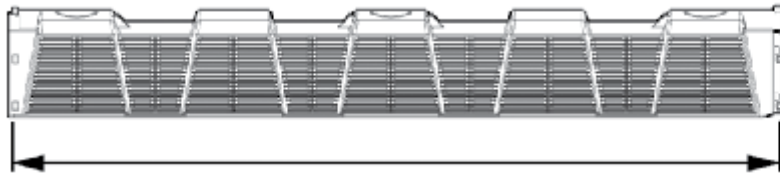

86” Effective Length



15”

Bio 2 End Cap - Side, and End Views (not to scale)



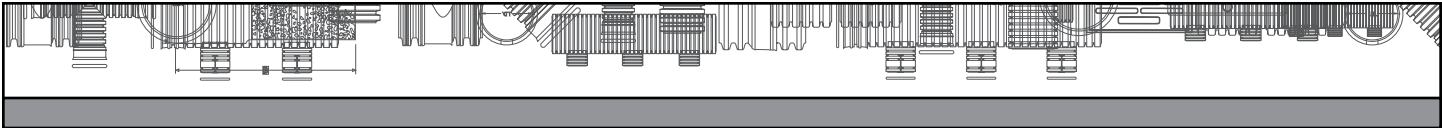

Bio 2 System

Bio 2 Features

- Side flanges on the chambers ends over lock during final engagement to form a very strong joint.
- The Bio 2 chamber feet are designed with an extra large surface area to provide support, particularly in sandy soils.
- Sidewall louvers are designed to allow effluent to exit the chamber sidewalls in high flow situations, while preventing soils from migrating into the chamber void.
- Observation/venting knockout ports provide for inspection of system performance as well as a convenient location for drain field ventilation pipes.
- Each chamber post end has small holes on either side of the post. When removed, these allow for the use of zip ties to support piping in low pressure dosing systems.
- BioDiffuser chambers can be installed to meet an H-10 live load (16,000 lbs/axle). Backfilling with a minimum of 12" of properly compacted cover is required for these applications.



• Over Locking Ends

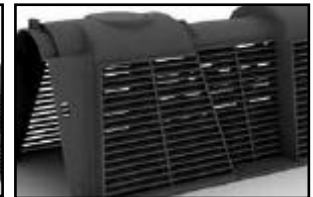

• Louvers and Feet



• Observation Port

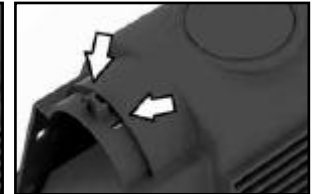

• Zip Tie Openings

Bio 2 Universal End Cap

- Upper and lower knockouts accommodate both Schedule 40 (4.5" OD) and SDR 35 (4.25" OD) pipes. Dimples are also offered for the positioning of hole saw pilot drills.
- End caps are designed to attach the chamber's dome or post end.



Bio 2 System Configurations

- Trench Installation: Page 18
- Bed Installation: Page 19
- Additional Configurations: Pages 20-23
(Serial, Pump and Pressure Dosing Options)

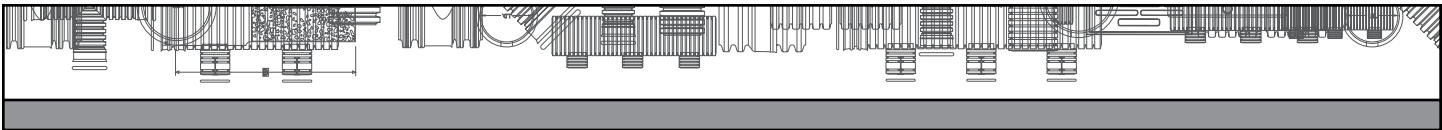

ARC/BIODIFFUSER LEACHING SYSTEMS: INSTALLATION PROCEDURES

Preparation

- Excavate to proper width and depth as described in the system design or permit and as required by state and local codes.
- Smooth irregularities in the excavation and clear any large rocks or debris from the bottom surface area. Slope of the bottom area shall be determined by the system design, as well as state and local codes. For bed installations, a minimum of 6 inches is required between chamber rows.

Installation

- Installation of the any ADS/Hancor Arc/BioDiffuser leaching system begins with laying the first chamber onto the prepared bottom surface area, with the “dome” end of the chamber at the header end of the excavation. Each additional incoming chamber is then installed by placing its dome over the post of the chamber already in place. As you lower the chamber to the ground, pull it towards you to engage the locking mechanism.

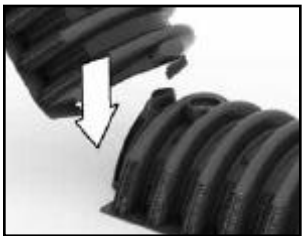

- As the incoming chamber is lowered down onto the excavation bottom, the two chambers fully engage in a straight-line pattern creating a very strong joint.

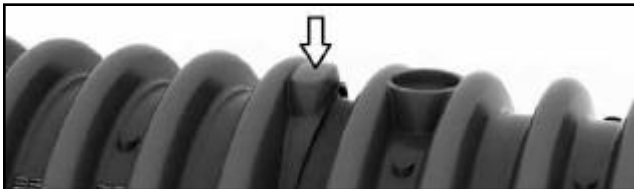

(Note: if the following chamber is simply laid onto the preceding chamber the joint will not be fully engaged.)

Turns

- The Arc 36, Arc 36 HC and Arc 18 chambers are designed with an articulating joint that allows for a turn of up to 20°, with maximum of 10° in either direction.

(Note: The Arc 18 is designed with lockout tabs)



- If a turn application is desired with the Arc 18 chamber, the lockout tab should be removed before installing the incoming chamber. The lockout tab is located at the base flange of the previously-installed chamber (on its “Post” end).
- Remove the lockout tab and clean any remaining tab material away from the chamber.

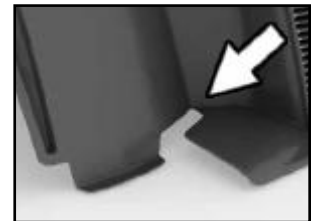
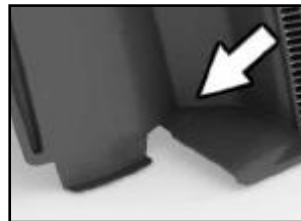

Installation of End Caps & Pipe Connections

- Prior to installing end caps, remove the appropriate knockout for pipe connections. Snap an end cap on each end of the drain lines with the product or company logo facing out (knockouts can be removed with a knife or a 4" hole saw).



- Upper end cap 4" knockouts — always used as inlet for each line. A four-inch hole saw may be used.
- Lower end cap 4" knockouts — used for return lines or continuous circuit piping per state or local code. These lower knockouts may also be used to create turns in the drain lines greater than the ten degrees provided by the chamber swivel feature.

Splash Plates

- Splash plates must be installed on each **inlet** end cap.
- Splash plates are provided with Arc system end caps.
- Knockout material may be used if screwed to the base flange of the end cap with a stainless steel screw.

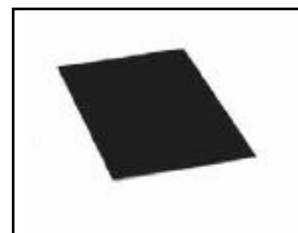

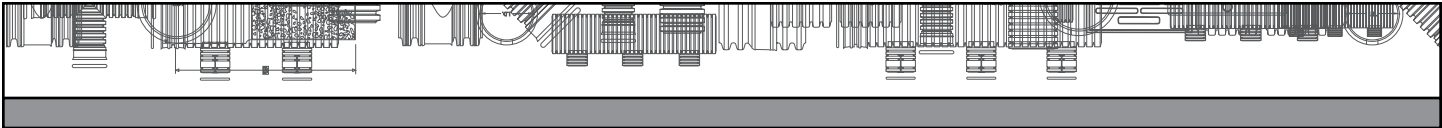

ARC/BIODIFFUSER LEACHING SYSTEMS: INSTALLATION PROCEDURES

Ventilation

Drain field ventilation is recommended, but not required, to allow oxygen to access the drain field especially when cover soil quality is questionable.

- Knockouts are provided on the 11" Standard, Arc 36, and Bio 3 chambers. The dome/post feature of the Arc 18 chamber also acts as a knock-out for observation/vent ports. Here a PVC pipe may be introduced into the chamber and vented to atmosphere.
- Make certain the vent is assembled in such a fashion as to prevent rainwater from entering, effluent water from exiting, and possible odors from causing issues.
- Several outlet products are available for this purpose.

Backfilling

- After chamber assembly is completed, fill to top of chambers with preferably compactible, slightly limited to moderately limited soil.
- Backfill material to meet Maine Backfill standard: 804.2 Backfill standards: The backfill material shall be a coarse sand to a gravelly coarse sand which meets the following requirements:
 - 804.2.1 Coarse fragments: The upper limit of coarse fragments shall be 3 inches in diameter and approximately 5% by volume;
 - 804.2.2 Textural analysis: The soil texture for backfill, unless otherwise authorized by this code, is coarse sand to gravelly coarse sand with approximately 4 to 8% of the sand, silt and clay fraction passing a #200 sieve. The upper limit of clay sized particles in the sand, silt, and clay fraction shall be approximately 2%. The backfill shall contain approximately 15% to 30% (by weight) coarse fragments (gravel 2 mm to 3 inches).

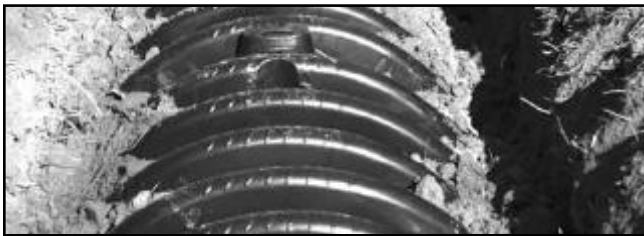

- Modestly compact the sidewall area backfill material by simply walking down the sides of the chambers. Sidewall compaction is important to begin the stabilization process of the soil, to support the chamber sidewalls, and help prevent fine sand migration into the chamber louvers. This procedure may be accomplished any time during the installation or covering process.



- All Arc/BioDiffuser chambers are H-10 load rated. Where vehicular loading is anticipated, H-10 loading (16,000 lbs/axle) is achieved by backfilling with a minimum of 12" of properly compacted cover.
- Do not drive heavy equipment over a system comprised of non-compacted cover material without first bridging the excavation. Use lightweight or tracked equipment to push the soil onto the system to the proper height set forth by local and state codes.

Final Grade

- Make certain that storm water is diverted away from the drain field. System final grade should be crested or sloped, never left flat or concave. Channel water away from the drain field.
- Final grading subcontractors and landscapers should be alerted and instructed to proper covering procedures, cover materials, and finish contours and elevations.
- Final grade material should be slightly to moderately limited soil to help maintain an aerobic state in the drain field.
- Stabilize the drain field area with grass-type vegetation prior to heavy rains if possible.

Mound Installation Procedure

- Review Plans and stake out the entire leaching bed area. Confirm elevations of the septic tank, distribution box and chambers.
- Clear and scarify entire leachfield area including fill extensions.
- Confirm backfill material meets the Maine 804.2 Backfill Standard. Place backfill material and use the teeth on the bucket to mix with the original soil. Place backfill material in 12in lifts (300mm), compact using a track vehicle. Continue placing backfill material to the bottom elevation of the chambers.
- Refer to standard installation procedures on page 16 and continue from Installation heading.

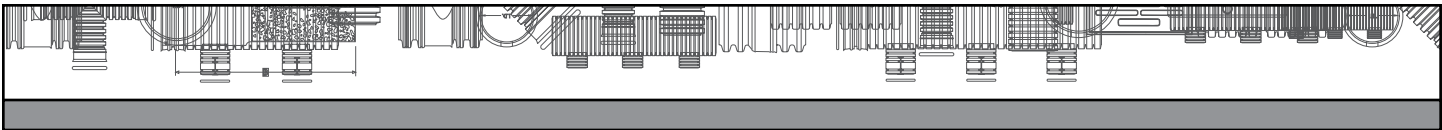

Typical Installation:

I. Trench Configuration

- The typical installation is used in most applications.

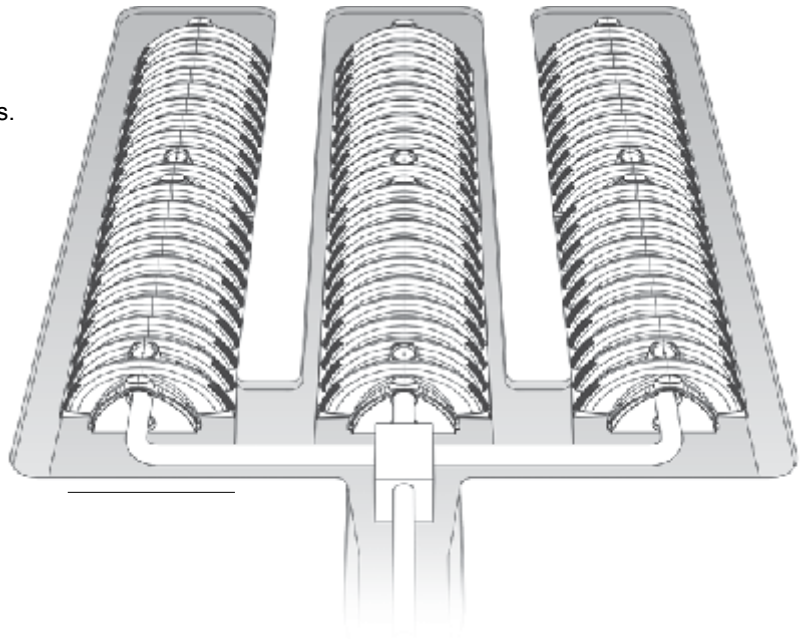

Typical Trench: Cross Section

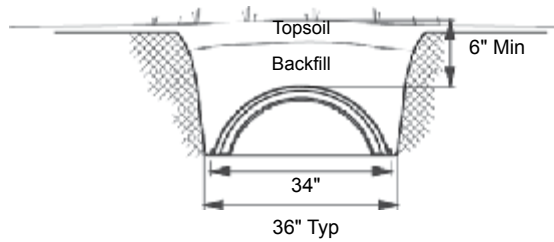

Typical Trench: Plan View

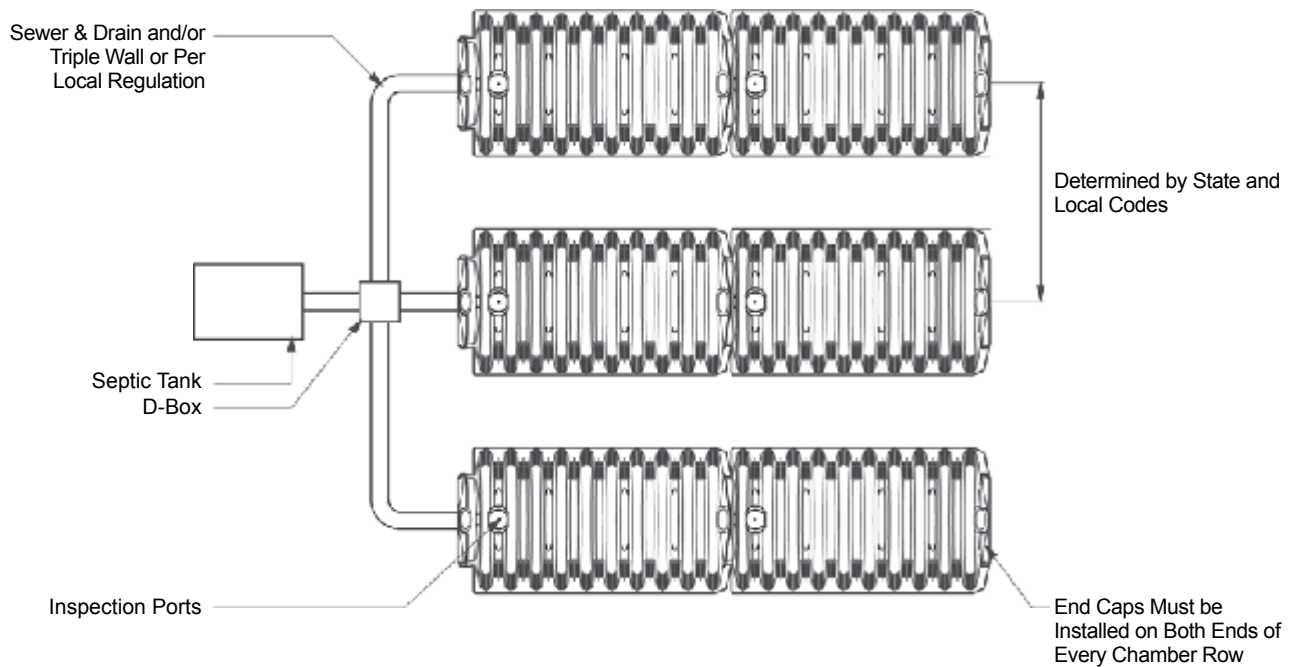

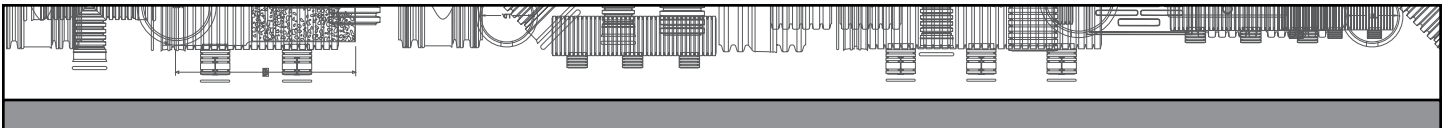

Typical Installation:

II. Bed Configuration

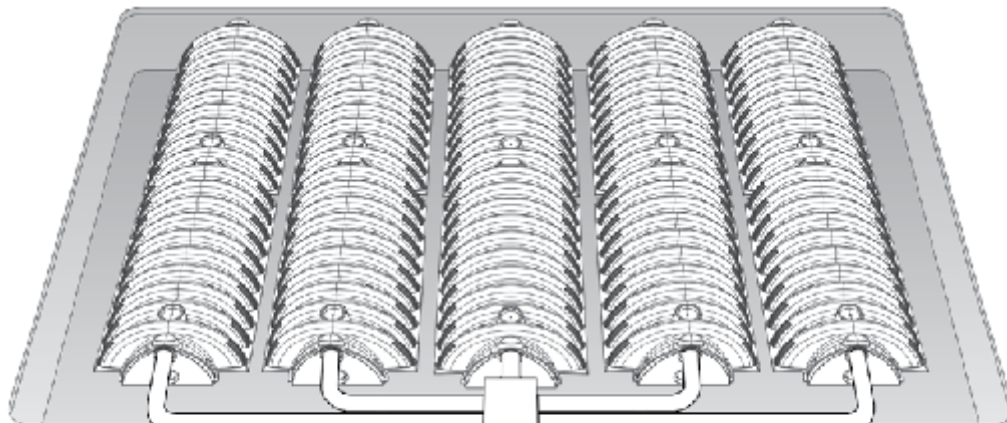

Typical Bed: Cross Section

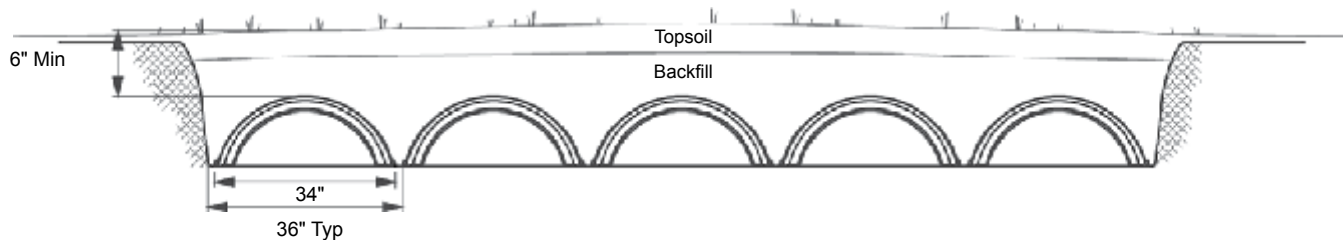

Typical Bed: Plan View

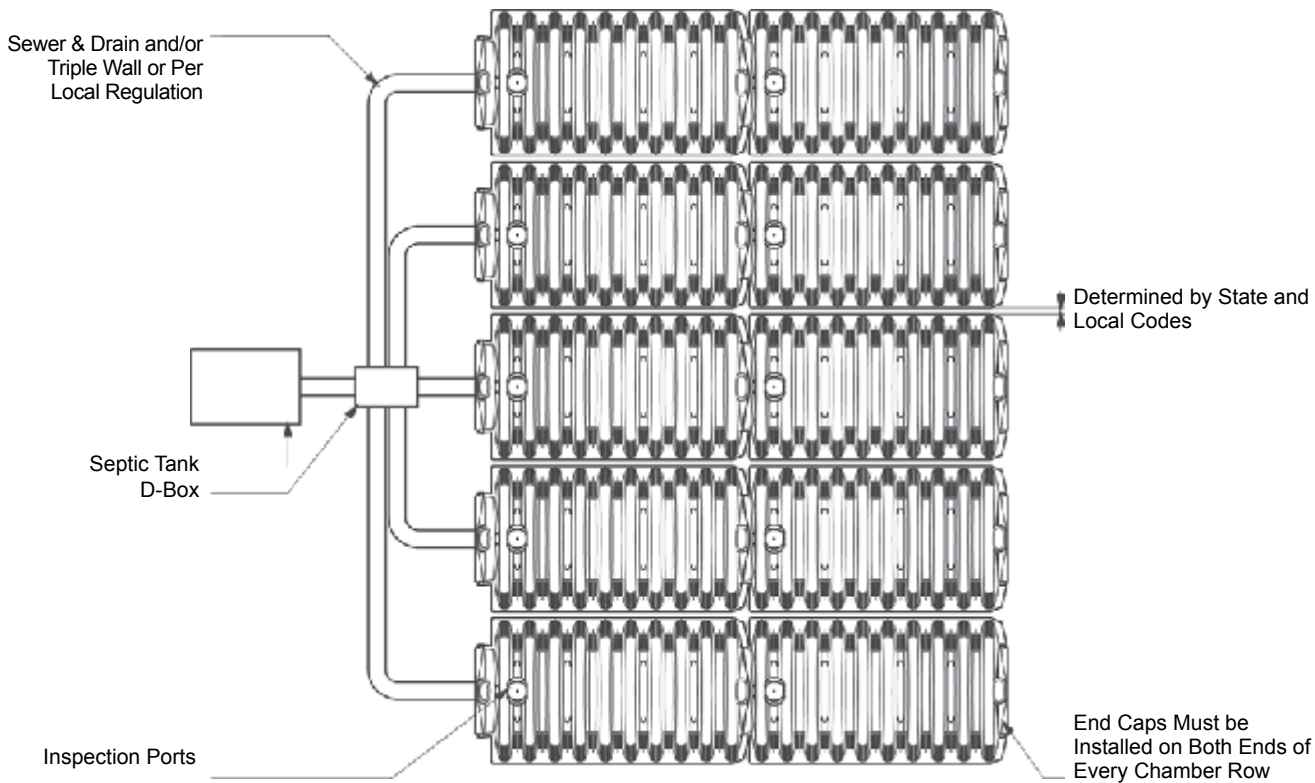

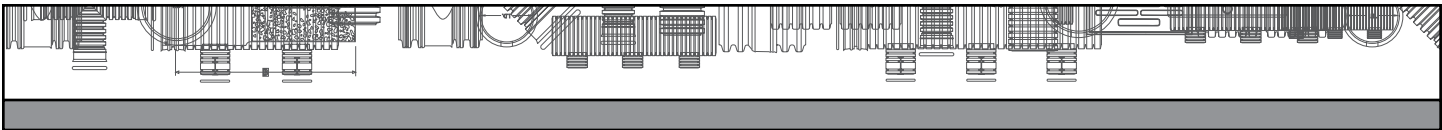

Typical Configurations:

III. Serial Configuration
 – Direct (End Cap-to-End Cap)

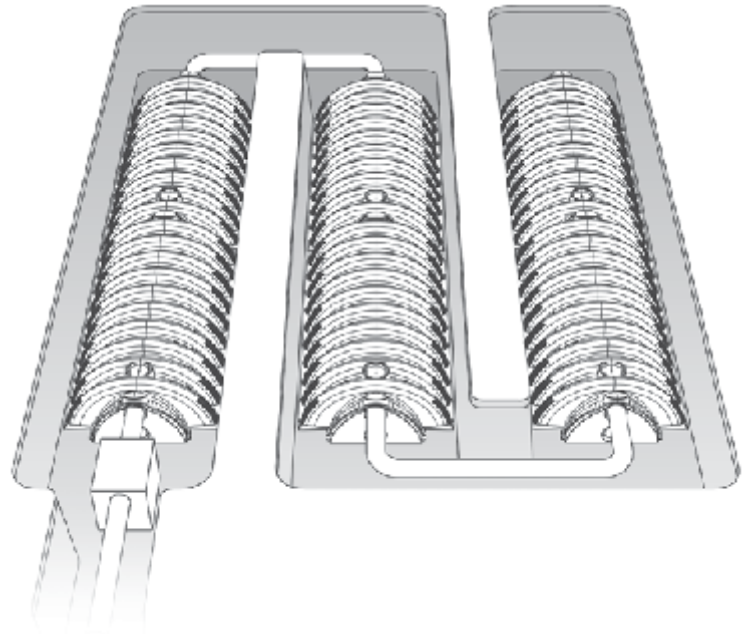

Serial to Direct: Cross Section (slope)

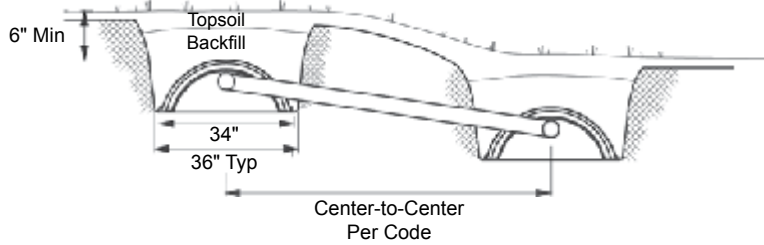

Serial to Direct: Plan View

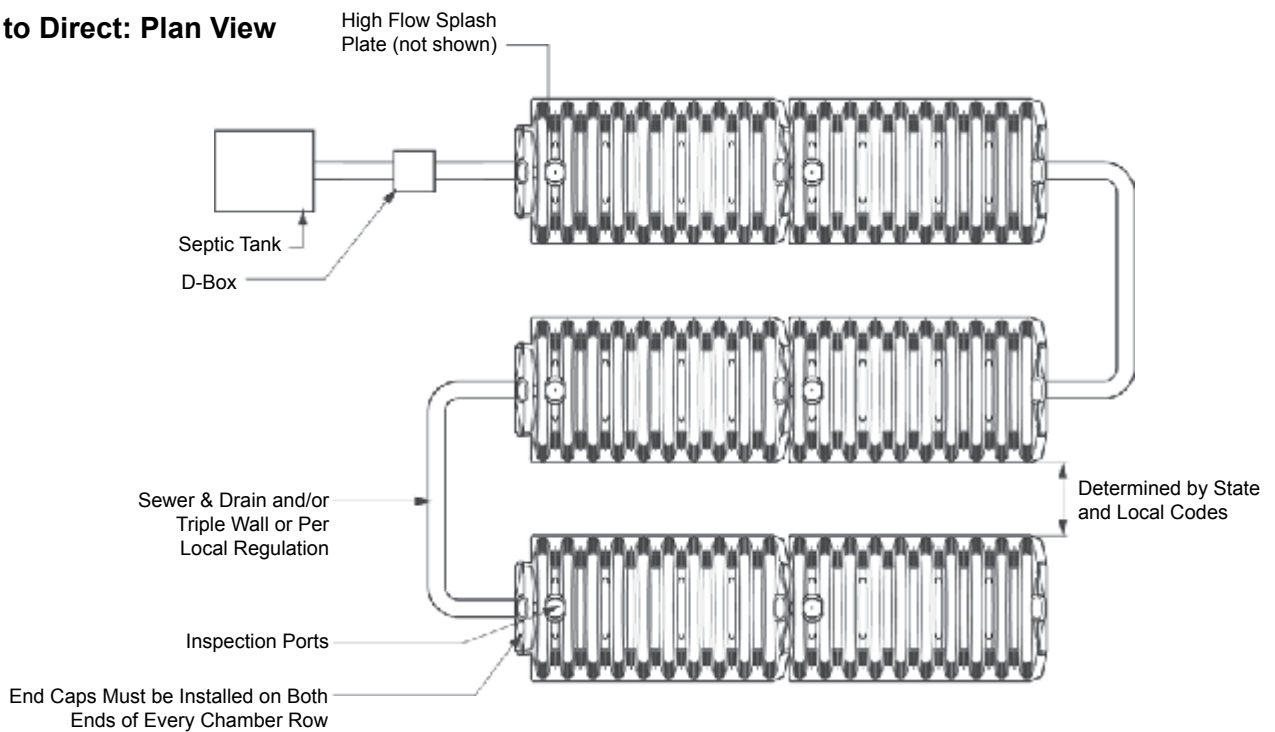

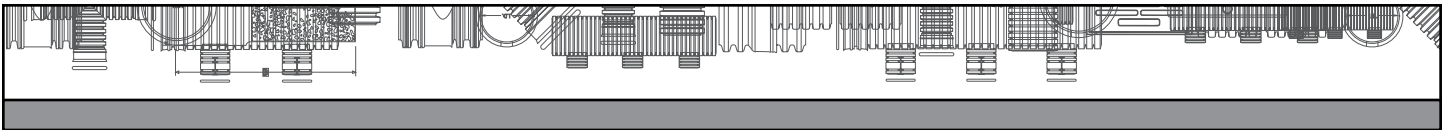

Additional Configurations:

I. Mound Configuration

Cross Section:

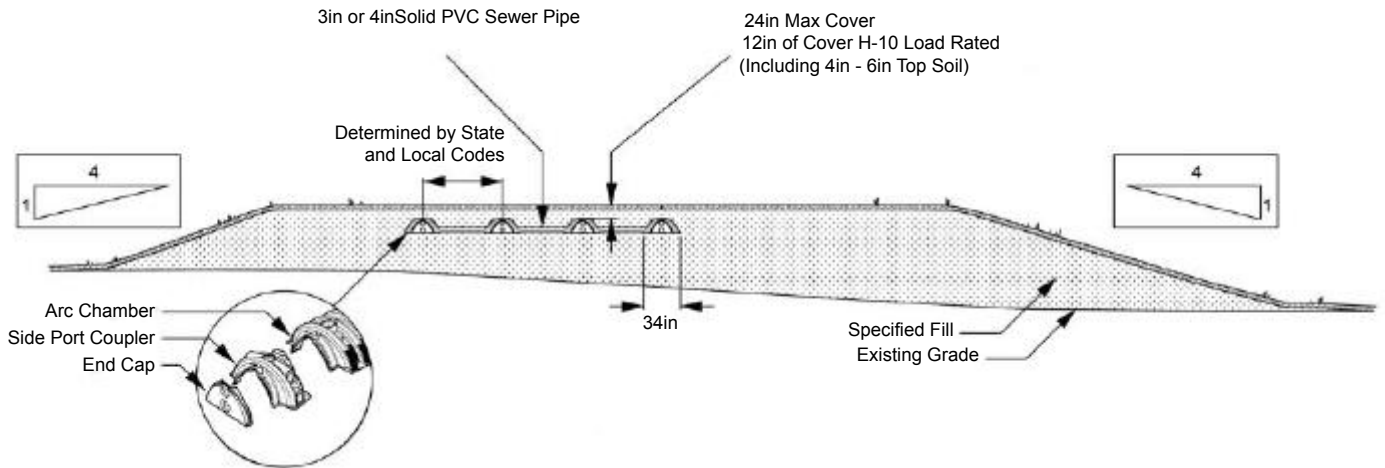

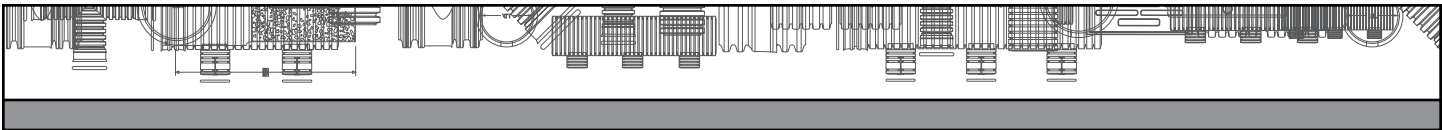

Additional Configurations:

II. Pump Systems: Pump to D-Box – For Equal Length Chamber Rows

Pump to D-Box: D-Box Section View

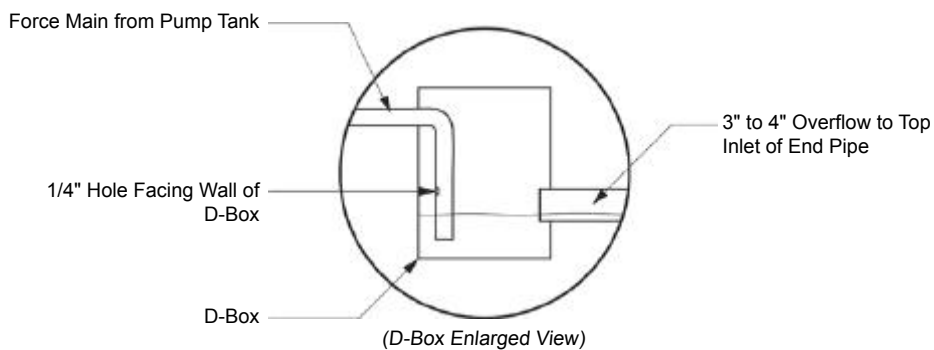

Pump to D-Box: Plan View

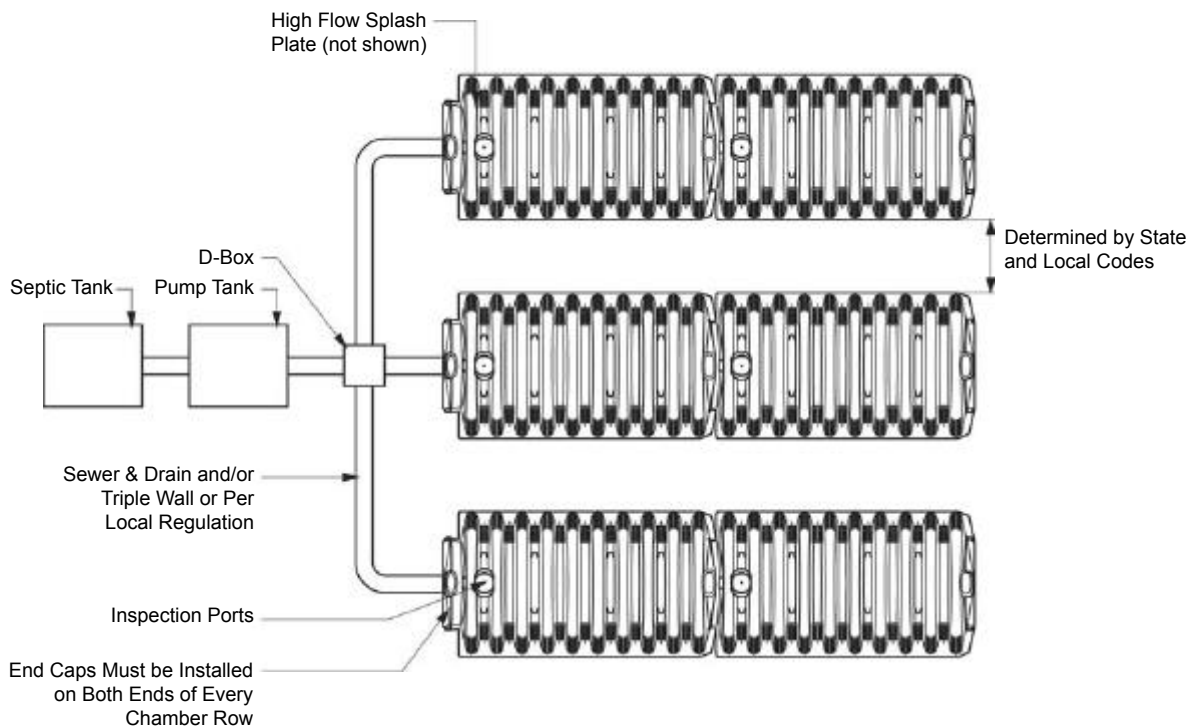

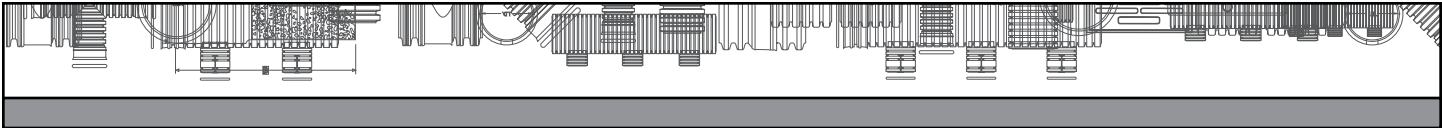

Additional Configurations:

III. Pump Systems: Pump to Serial – For Sloping Terrain

Pump to Serial: Plan View

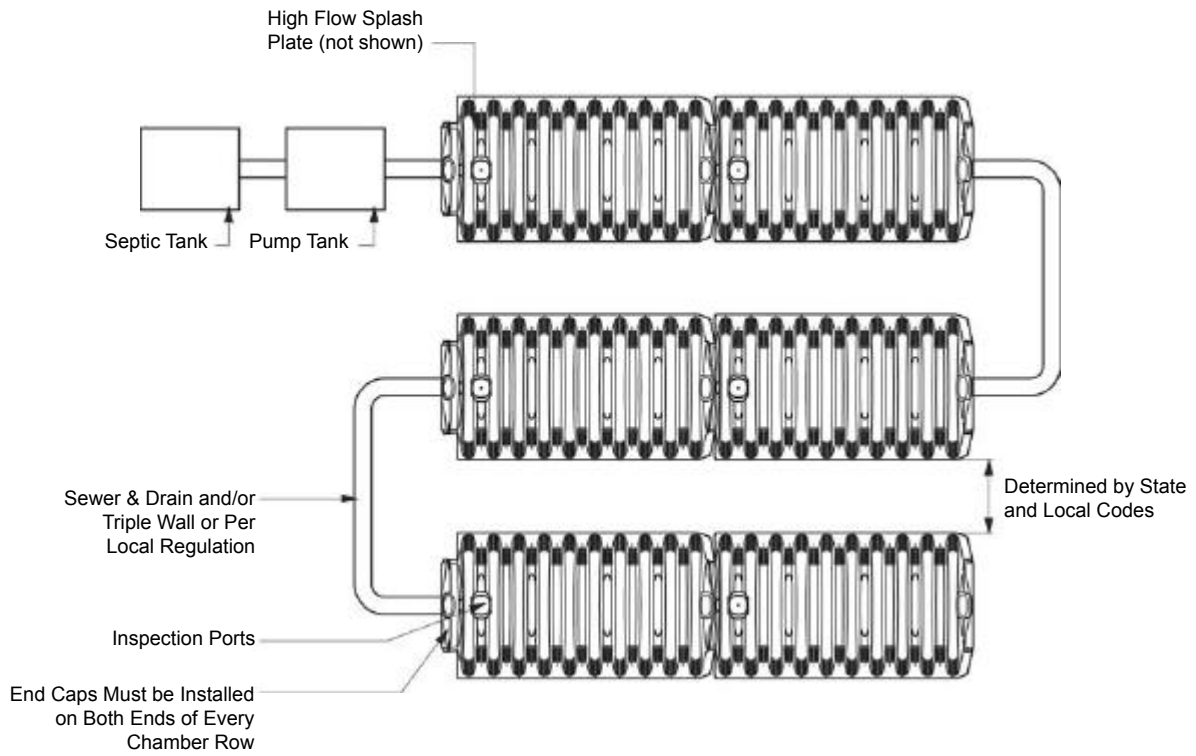

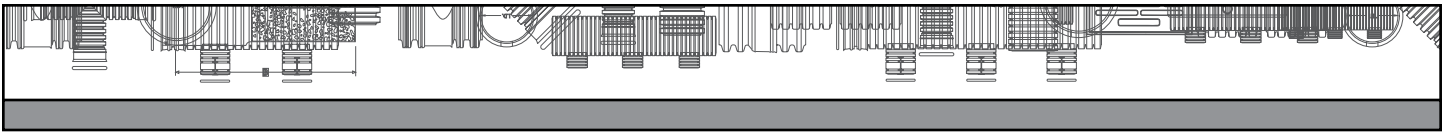

Additional Configurations:

IV. Pressure Dosing System

Pressure Dosing: Plan View

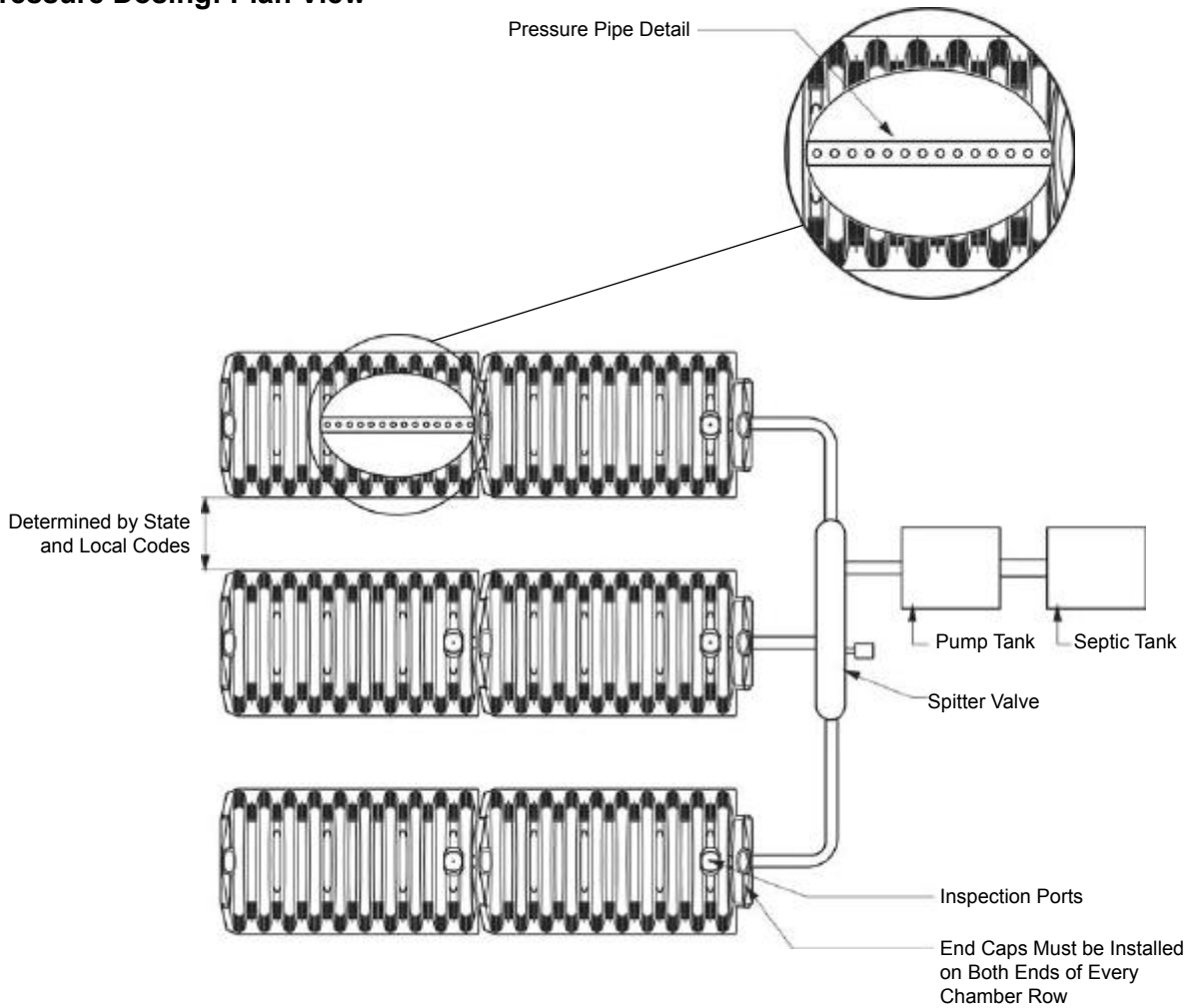

Pressure Dosing: Pipe Support Installation Cross Section

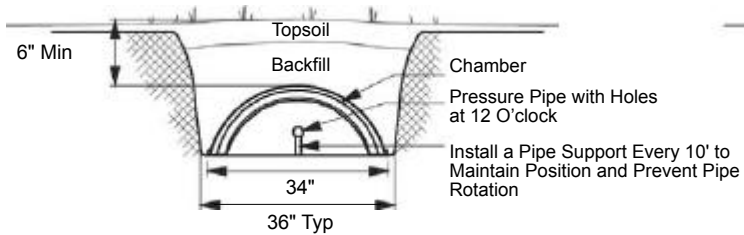

Pressure Dosing: Pipe Support Installation Cross Section

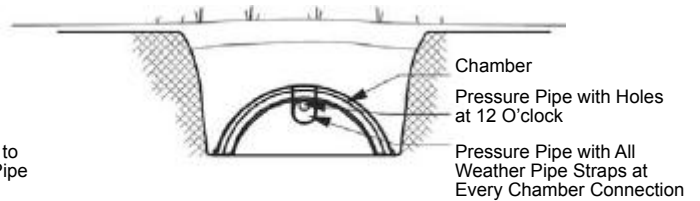

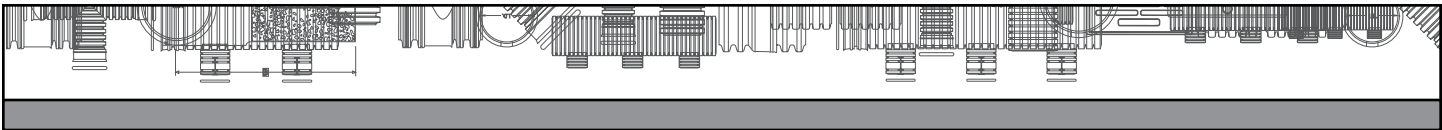

Additional Configurations:

V. Side Port Layout – Header- Middle - Radius

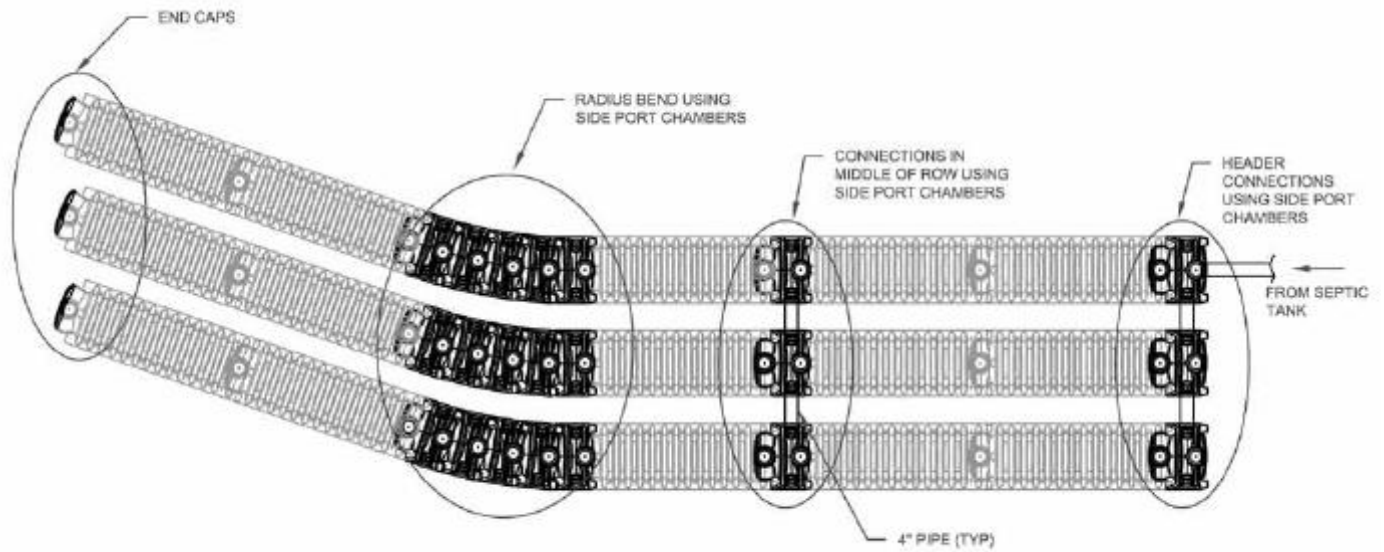

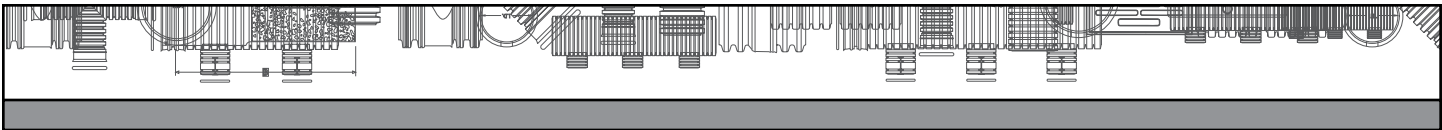

Additional Configurations:

VI. Side Port Layout – Serial

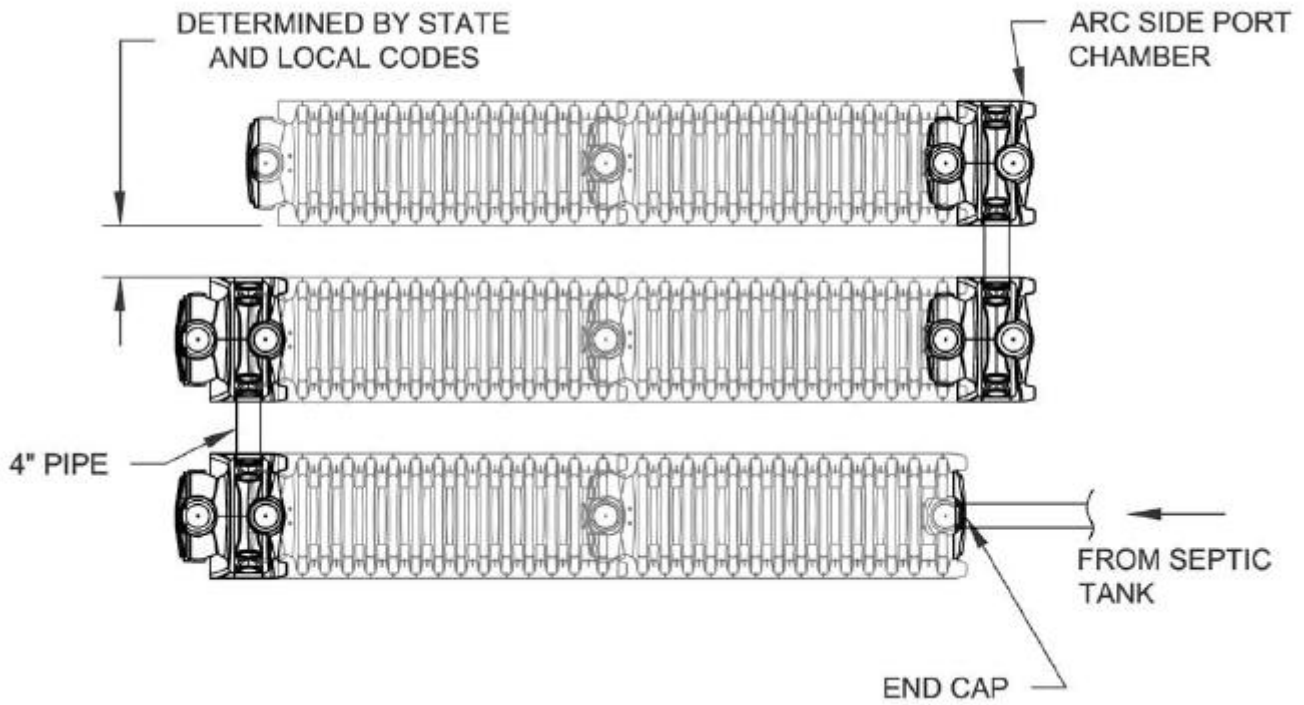

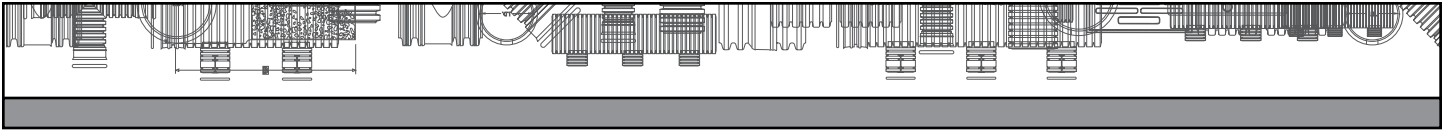

Sizing of ARC 36 Standard Chamber For Trench Systems

Chambers are to be installed with 3 foot trench separation from edge to edge

The following table will determine the minimum number of chambers needed (For Residential Use)

Soil Profile	Number of Bedrooms					Additional Bedroom 90 GPD
	2	3	4	5	6	
	180 GPD	270 GPD	360 GPD	450 GPD	540 GPD	
1	22	33	43	53	65	12
2	18	26	35	43	52	9
3	18	26	35	43	52	9
4	15	22	28	35	42	8
5	15	22	28	35	42	8
6	15	22	28	35	42	8
7	18	26	35	43	52	9
8	22	33	43	53	65	12
9	26	39	52	65	78	13

Notes:

1. The effective length of the ARC 36 standard chamber is 60-inches.
2. Sizing credit for the Arc 36 standard chamber equals 35 sq. ft. per chamber or 7.0 sq. ft. linear foot.
3. Arc 36 SPC sizing credit of 6.0 sq. ft. per unit.

Sizing of ARC 36 High Capacity Chamber For Trench Systems

Chambers are to be installed with 3 foot trench separation from edge to edge

The following table will determine the minimum number of chambers needed (For Residential Use)

Soil Profile	Number of Bedrooms					Additional Bedroom 90 GPD
	2	3	4	5	6	
	180 GPD	270 GPD	360 GPD	450 GPD	540 GPD	
1	19	29	38	47	57	10
2	15	23	30	38	45	8
3	15	23	30	38	45	8
4	13	19	24	30	37	7
5	13	19	24	30	37	7
6	13	19	24	30	37	7
7	15	23	30	38	45	8
8	19	29	38	47	57	10
9	23	34	45	57	68	12

Notes:

1. The effective length of the ARC 36 high capacity chamber is 60-inches.
2. Sizing credit for the ARC 36 high capacity chamber equals 40 sq. ft. per chamber or 8.0 sq. ft. per linear foot.
3. Arc 36 high capacity SPC sizing credit of 6.0 sq. ft. per unit.

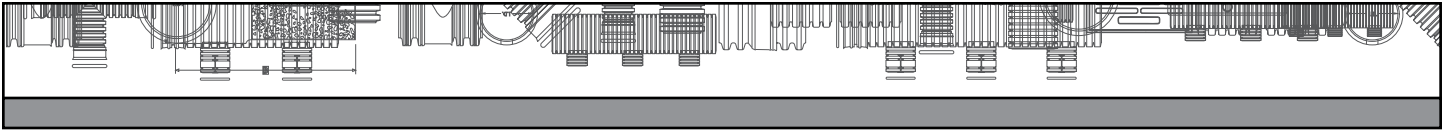

Sizing of 1100BD Standard Chamber For Trench Systems

Chambers are to be installed with 3 foot trench separation from edge to edge

The following table will determine the minimum number of chambers needed (For Residential Use)

Soil Profile	Number of Bedrooms					Additional Bedroom 90 GPD
	2	3	4	5	6	
	180 GPD	270 GPD	360 GPD	450 GPD	540 GPD	
1	17	26	34	42	51	9
2	14	21	27	34	41	7
3	14	21	27	34	41	7
4	11	16	22	27	32	6
5	11	16	22	27	32	6
6	11	16	22	27	32	6
7	14	21	27	34	41	7
8	17	26	34	42	51	9
9	21	31	41	52	62	11

Notes:

1. The effective length of the 1100BD standard chamber is 75-inches.
2. Sizing credit for the 1100BD chamber equals 44 sq. ft. per chamber or 7.0 sq. ft. per linear foot.

Sizing of 1500BD Bio 2 Narrow Chamber For Trench Systems

Chambers are to be installed with 18-inch trench separation from edge to edge

The following table will determine the minimum number of chambers needed (For Residential Use)

Soil Profile	Number of Bedrooms					Additional Bedroom 90 GPD
	2	3	4	5	6	
	180 GPD	270 GPD	360 GPD	450 GPD	540 GPD	
1	27	39	52	65	77	14
2	21	32	42	52	60	11
3	21	32	42	52	60	11
4	18	26	33	42	50	10
5	18	26	33	42	50	10
6	18	26	33	42	50	10
7	21	32	42	52	60	11
8	27	40	52	65	77	14
9	33	48	64	79	95	16

Notes:

1. The effective length of the 1500BD Bio 2 narrow chamber is 86-inches.
2. Sizing credit for the 1500BD Bio 2 narrow chamber equals 28.8 sq. ft. per chamber or 4.0 sq. ft. per linear foot.

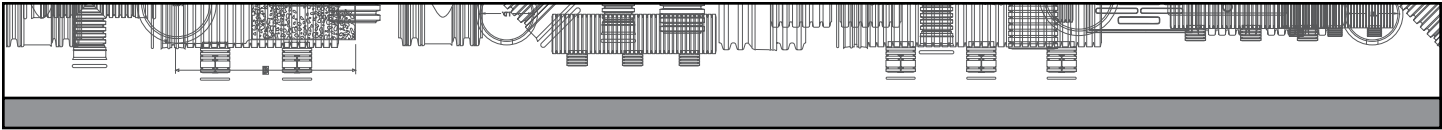

Sizing of 1600BD High Capacity Chamber For Trench Systems

Chambers are to be installed with 3 foot trench separation from edge to edge

The following table will determine the minimum number of chambers needed (For Residential Use)

Soil Profile	Number of Bedrooms					Additional Bedroom 90 GPD
	2	3	4	5	6	
	180 GPD	270 GPD	360 GPD	450 GPD	540 GPD	
1	15	23	30	37	45	8
2	12	18	24	30	36	6
3	12	18	24	30	36	6
4	10	15	19	24	29	5
5	10	15	19	24	29	5
6	10	15	19	24	29	5
7	12	18	24	30	36	6
8	15	23	30	37	45	8
9	18	27	36	45	54	9

Notes:

1. The effective length of the 1600BD high capacity chamber is 75-inches.
2. Sizing credit for the 1600BD high capacity chamber equals 50 sq. ft. per chamber or 8.0 sq. ft. per linear foot.

Sizing of ARC 18 Narrow Chamber For Trench Systems

Chambers are to be installed with 18-inch trench separation from edge to edge

The following table will determine the minimum number of chambers needed (For Residential Use)

Soil Profile	Number of Bedrooms					Additional Bedroom 90 GPD
	2	3	4	5	6	
	180 GPD	270 GPD	360 GPD	450 GPD	540 GPD	
1	38	58	75	93	113	20
2	30	45	60	75	90	15
3	30	45	60	75	90	15
4	25	38	48	60	73	13
5	25	38	48	60	73	13
6	25	38	48	60	73	13
7	30	45	60	75	90	15
8	38	58	75	93	113	20
9	45	68	90	113	135	23

Notes:

1. The effective length of the ARC 18 narrow chamber is 60-inches.
2. Sizing credit for the ARC 18 narrow chamber equals 20 sq. ft. per chamber or 4.0 sq. ft. per linear foot.

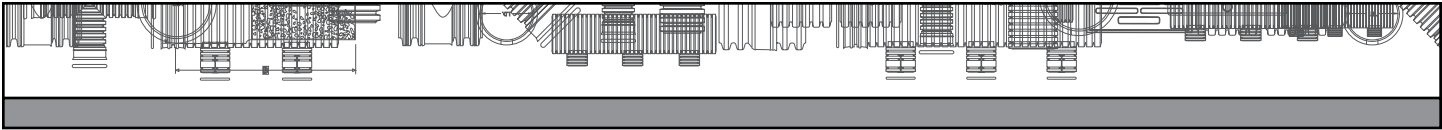

Sizing of ARC 36 & 36 High Capacity Chambers For Cluster Systems

Recommended 6-inch separation between chamber rows

The following table will determine the minimum number of chambers needed (For Residential Use)

Soil Profile	Number of Bedrooms					Additional Bedroom 90 GPD
	2	3	4	5	6	
	180 GPD	270 GPD	360 GPD	450 GPD	540 GPD	
1	26	40	52	65	79	14
2	21	32	42	52	63	11
3	21	32	42	52	63	11
4	18	26	33	42	51	9
5	18	26	33	42	51	9
6	18	26	33	42	51	9
7	21	32	42	52	63	11
8	26	40	52	65	79	14
9	32	47	63	79	94	16

Notes:

1. The effective length of the ARC 3613BD2 & 3616BD2 chambers is 60-inches.
2. Sizing credit for the ARC 3613BD2 & 3616BD2 chambers (bottom area only) equals 29 sq. ft. per chamber or 5.8 sq. ft. per linear foot.

Sizing of 1100BD & 1600BD Chamber For Cluster Systems

Recommended 6-inch separation between chamber rows

The following table will determine the minimum number of chambers needed (For Residential Use)

Soil Profile	Number of Bedrooms					Additional Bedroom 90 GPD
	2	3	4	5	6	
	180 GPD	270 GPD	360 GPD	450 GPD	540 GPD	
1	21	31	41	52	62	11
2	17	25	33	42	50	9
3	17	25	33	42	50	9
4	13	20	26	33	39	7
5	13	20	26	33	39	7
6	13	20	26	33	39	7
7	17	25	33	42	50	9
8	21	31	41	52	62	11
9	25	38	50	63	75	13

Notes:

1. The effective length of the 1100BD & 1600BD chambers is 75-inches.
2. Sizing credit for the 1100BD & 1600BD chambers (bottom area only) equals 36 sq. ft. per chamber or 5.76 sq. ft. per linear foot.

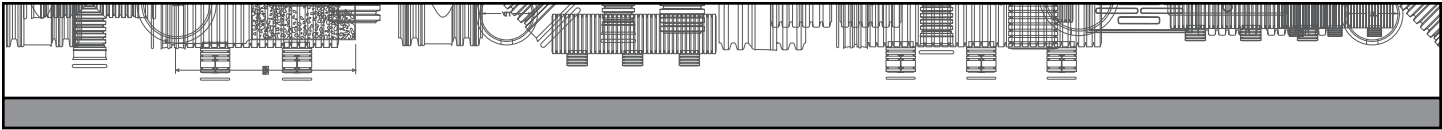

Innovation in product, process and technology.

That's ADS and Hancor.

Beginning with single wall corrugated polyethylene pipe, ADS and Hancor have continually introduced drainage products that have set the industry standard – bringing to market a remarkable alternative to concrete and steel pipe. Our commitment to being the best means that we continue to refine the structural design of our pipe and redefine the limits of its application in the structural design community.



1-800-821-6710
www.ads-pipe.com



888-FOR PIPE (367-7473)
www.hancor.com